

USING THIS GUIDE

This reference and programming guide contains condensed specifications, a summary of front panel operating controls, and IEEE-488 programming commands and examples for the Models 194A, 1941, and 1944A. It is intended to provide a quick reference to the many available features of your instrument as well as the many programming commands available to control the instrument over the IEEE-488 bus.

Because of the limited amount space available in this guide, many details about instrument operation will not be found here. Refer to the Model 194A Instruction Manual for aspects of instrument operation not covered in this guide.

This guide describes the following aspects of the Model 194A:

- Front panel operation including XY mode.
- A description of mathematical functions.
- Input and output signal connections.
- IEEE-488 programming information, including commands, data and status formats, and example programs for typical controllers.

©1989, Keithley Instruments, Inc.
28775 Aurora Road
Cleveland, Ohio 44139
Document Number: 194A-900-01 Rev. A

CONTENTS

CONDENSED SPECIFICATIONS	4
ENGINEERING UNITS CONVERSION	5
SAFETY PRECAUTIONS	6
FRONT PANEL FEATURES AND OPERATION	7
Display	
Annunciators	
General Display Messages	
Shift Functions	
Mathematical Functions	
Ratio and Difference Modes	
Range	
Data Entry	
Programmable Parameters	
Rate and Samples Programming	
Recalling Data	
Trigger	
Channel Selection	
Input Coupling	
Zero	
Filter	
FRONT PANEL PROGRAMS	25
Setup	
Status	
Reset	
XY Mode	
INPUT AND OUTPUT CONNECTIONS	31
A/D Module Input/Output Connections	
Analog Output Connections	
External Clock	
IEEE-488 PROGRAMMING	35
Device-dependent Commands	
TRANSLATOR MODE	56
CONTROLLER PROGRAMS	58
IBM XT or PC (with CEC Interface)	
Hewlett-Packard 300 Series Compac	
ASCII CHARACTER CODES AND IEEE-488	
MULTILINE INTERFACE COMMAND MESSAGES ...	62

CONDENSED SPECIFICATIONS

DC Characteristics

16-bit Range Resolution Accuracy 1 year 18-28°C ±(%rdg + offset)			8-bit Range Resolution Accuracy 1 year 18-28°C ±(%rdg + offset)	
320mV	10 μ V	0.03+200nV	2.56mV	0.42+2.56mV
3.2V	100 μ V	0.025+2mV	25.6mV	0.42+25.6mV
32V	1mV	0.035+20mV	256mV	0.42+256mV
200V	10mV	0.035+200mV	2.56V	0.42+2.56V

INPUT IMPEDANCE: 1M Ω in parallel with less than 47pF.

MAXIMUM ALLOWABLE INPUT: 250V peak, 2 \times 10⁷ Hz.

MAXIMUM SAMPLING RATE: 1MHz at 8-bit resolution;
100kHz at 16-bit resolution.

MATH FUNCTIONS: Average, Peak, Peak-to-Peak, TRMS,
Standard Deviation, Integral, Waveform.

FRONT PANEL PROGRAMS: IEEE-488 Address, Self Test,
Digital Calibration, Calibration Storage, X Output Full Scale,
Y Output Full Scale, Z Output Blanking Level.

DISPLAY: Fourteen digit alphanumeric LED display.

RANGING: Manual or autoranging.

CONNECTORS: All I/O connectors are BNC except Real
Time Output (DB-25) and IEEE-488 connectors.

ENGINEERING UNITS AND SCIENTIFIC NOTATION CONVERSION

Prefix	Engineering Symbol	Scientific Notation
femto-	f	10^{-15}
pico-	p	10^{-12}
nano-	n	10^{-9}
micro-	μ	10^{-6}
milli-	m	10^{-3}
kilo-	k	10^3
mega-	M	10^6
giga-	G	10^9
tera-	T	10^{12}
peta-	P	10^{15}

SAFETY PRECAUTIONS

The following safety precautions should be observed before using the Model 194A:

1. Before operation, ground the instrument through a properly earth grounded power receptacle.
2. Do not exceed 30V rms between input low and earth ground.
3. Do not exceed the maximum allowable input as defined in the condensed specifications section of this guide.
4. Before servicing, disconnect the Model 194A from the power line and all other equipment.
5. Do not touch any terminals while the instrument is turned on or connected to any other equipment or sources.

FRONT PANEL FEATURES AND OPERATION

DISPLAY

DESCRIPTION

The Model 194A display consists of fourteen 14-segment LED units which display both instrument readings as well as many messages to augment the various operational modes. The basic display format for readings includes the voltage value, units (mV or V), mathematical function (for example AVG for average) and channel number (1 or 2). Channel 2 is available only for those units equipped with a Model 1944A A/D module in the CARD 2 location.

The display can be operated single-channel or dual-channel, as selected with the CHANNEL button. The selected channel also dictates which channel is affected by pressing other buttons. Most other modes cannot be changed when the display is in the dual-channel mode.

DISPLAY EXAMPLES

Typical examples for the display modes include:

Channel 1 Average Reading: -1.2500 V AVG 1.

Channel 2 TRMS Reading: 0.3450 mV RMS 2.

Dual Channel Reading: -1.2500 0.3450

ANNUNCIATORS

Front panel annunciators indicate when a number of front panel modes are selected as described below:

IEEE-488 STATUS: The TALK, LISTEN, and REMOTE indicators show when the instrument has been placed in those respective modes via programming commands sent over the IEEE-488 bus. These indicators are not operational during front panel operation.

ZERO: Indicates when a baseline measurement is being subtracted from subsequent measurements.

FILTER: Shows when either the 50kHz or 500kHz analog filters are enabled.

SGL/CONT: Indicates when the instrument is in the single or continuous trigger.

SLOPE: Shows whether the instrument will be triggered on the rising or falling edge of an input signal waveform.

CPLG: Indicates ac or dc input coupling. Ground coupling is selected when both indicators are off.

AUTO: Shows when the instrument is in the autorange mode.

SHIFT: Shows when the shift mode has been enabled by pressing the shift key. Shifted modes are marked below the respective control buttons.

RECALL: Indicates when the recall mode is in effect. This mode allows access to individual samples in the measurement buffer.

GENERAL DISPLAY MESSAGES

Display messages that may occur during general front panel operation are summarized below. The unit also has a number of specific messages associated with the various operating modes, as described in the instruction manual.

MESSAGE	DESCRIPTION
OFLO	Overrange input applied for at least one sample.
SHIFTLESS KEY	Shift function invoked for key not having one.
NMBR TOO SMALL	Too small a value keyed in during data entry.
NMBR TOO LARGE	Too big a value keyed in during data entry.

SHIFT FUNCTIONS

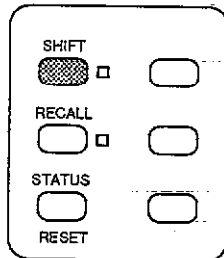

DESCRIPTION

Many of the front panel keys have a secondary function which is placed into affect by pressing the **SHIFT** key before pressing that particular button. Each shifted function is listed below the key in question. For example, pressing **SHIFT ZERO VAL** allows a baseline value to be keyed in from the front panel. While the shift function is enabled, the associated indicator will be on. Pressing a key which does not have a shifted function will result in the following display message:

SHIFTLESS KEY

MATHEMATICAL FUNCTIONS

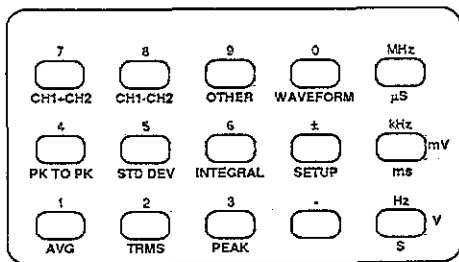

DESCRIPTION

The Model 194A has a number of mathematical functions that can be applied to the measurement. If the instrument

is in a continuous trigger mode, a single math function, once selected, can be applied to successive measurements. In a single trigger mode, a variety of different math functions can be applied to a single measurement. Each mathematical function can be enabled by pressing SHIFT followed by the corresponding key.

OPERATION

WAVEFORM: Displays the individual sample occurring at the trigger point, or the sample as close as possible to the trigger point. Example: 1.2345 V DC 1.

PK TO PK: Displays the peak-to-peak value of the measurement, which is calculated by subtracting the most negative sample from the most positive sample.
Example: 2.3410 V P-P 1.

STD DEV: Displays the standard deviation of the measurement, which shows how far the samples deviate from the average of the measurement. Example: -12.341 V STD 1.

INTEGRAL: Displays the integral of the measurement, which is the area under a curve bounded by the measurement amplitude and the measurement duration.
Example: 800.23 VS 2.

AVG: Shows the average of the measurement, which is calculated by dividing the sum of all the samples by the number of sample. Example: -16.225 V AVG 1.

TRMS: Displays the true rms value of the measurement. Example: 31.800 V RMS 1.

PEAK: Shows the most positive or most negative sample in the measurement. Example: 1.1220 V PK+ 1. Press repeatedly to alternate between positive and negative peak.

RATIO AND DIFFERENCE MODES

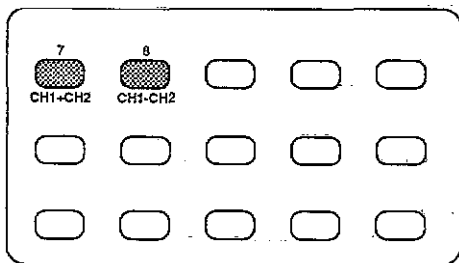

DESCRIPTION

The ratio and difference modes allow you to divide the channel 1 reading by the channel 2 reading or to subtract the channel 2 reading from the channel 1 reading. In order to use either of these modes, the optional Model 1944A A/D Module must be installed in the CARD 2 location. If there is no second channel installed, pressing either CH1-CH2 or CH1+CH2 module installed will result in the following message:

NO A/D IN CH 2

OPERATION

CH1÷CH2 (Ratio): To display the ratio between the two channels, press SHIFT CH1+CH2. The instrument will then display the ratio as in this example: 1.2367 V 1/2.

CH1-CH2 (Difference): To display the difference between the two channels, press SHIFT CH1-CH2. The instrument will then display the difference between the two channels, as in this example: 2.4000 V 1-2.

RANGE

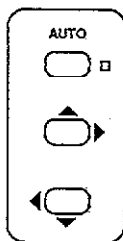

DESCRIPTION

The ranging controls give you control over sensitivity of the measurement. The range may be selected either on an automatic or manual basis. When using manual ranging, the lowest range possible without overranging the instrument should be used to maximize accuracy and resolution.

Available ranges and resolution are summarized below.

Range	8-bit Resolution	16-bit Resolution*
320mV	2.56mV	10 μ V
3.2V	25.6mV	100 μ V
32V	256mV	1mV
200V	2.56V	10mV

* 16 bit resolution at sampling rates 100kHz and lower.

OPERATION

AUTO: The AUTO button toggles the instrument between auto and manual ranging. The AUTO indicator will be on when in autoranging.

Uprange: Pressing uprange moves the instrument to the next higher range until the highest (200V) range is reached. Uprange also cancels autorange if that mode is presently enabled. Uprange is also used with various other functions such as data entry and recall.

Downrange: This key moves the instrument to the next lower range when pressed until the lowest (320mV) range is reached. Downrange also cancels autorange if enabled, and it is used with various other functions such as data entry and recall.

DATA ENTRY

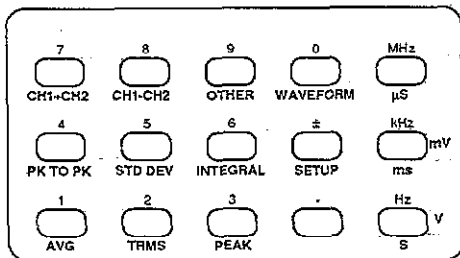

DESCRIPTION

The Data Entry keys allow the entry of numeric data into those functions requiring values. These keys are used to program values for rate, samples, trigger level, zero, and trigger delay. During the entry process, the keyed in digits will appear on the display.

OPERATION

Numeric Keys (0-9, +/-, .): These keys enter actual numeric data including decimal point and sign into the display after the appropriate function has been entered.

ENTER: Pressing ENTER actually enters keyed in data into the function in question.

CANCEL: May be used to cancel keyed in data and return to the previous value.

Units Keys (MHz, kHz, Hz): Determines the type of units to be keyed in. Voltage or time or frequency units are automatically chosen by the selected function. Pressing a units key automatically enters the displayed data.

FREQ/TIME: This key toggles the instrument between time (μ sec, msec, s) and frequency (MHz, kHz, Hz) units. For example, sampling rate may be entered either as time interval or sampling frequency units.

Cursor Control: During the data entry process, the digit affected by pressing a numeric key will be indicated by a flashing segment or digit. This cursor can be moved left or right with the downrange or uprange buttons, respectively.

PROGRAMMABLE PARAMETERS

Parameters to be programmed with the Data Entry keys are summarized below, along with limits and resolution of each parameter.

Function	Limits	Resolution
RATE	Time 1 μ sec-1sec Frequency 1Hz-1MHz	0.1 μ sec Hz
SAMPLES	No: 1-65,535* Time: 0 μ sec-65,534sec*	Samples 0.1 μ sec
DELAY	No Samples: -65,536 to 10 ⁷ Time: -65,536 to 10 ⁷ sec	Samples 0.1 μ sec
LEVEL	$\pm 200V$	μV
ZERO VAL	$\pm 200V$	μV
X Output	1-10V nominal	μV
Full Scale**		
Y Output**	1-10V nominal	μV
Full Scale		

*32,768 in 16-bit mode.

**Accessed with OTHER key.

RATE AND SAMPLES PROGRAMMING

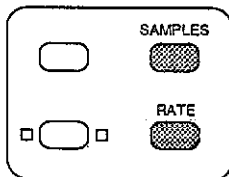

DESCRIPTION

A measurement is made up of a number of samples taken at specific intervals. The number of samples in that measurement, as well as how fast those samples are taken can be programmed with the SAMPLES and RATE keys. These parameters are entered with the Data Entry keys once the mode in question is enabled.

RATE: Sampling rate may be entered in time (1sec -1 μ sec) or frequency (1Hz-1MHz). To program sampling rate, press the RATE key and press the numeric buttons in the desired sequence. Press the **FREQ/TIME** key, as required, to enter *time or frequency units*.

SAMPLES: The size of the measurement may be entered as the number of samples (1-65,536) or measurement time duration (1 μ sec-65,536sec). To program the number of samples, press **SAMPLES** and then key in the desired value with the numeric keys. Use **FREQ/TIME** to select sampling interval or number of samples, as desired.

RECALLING DATA

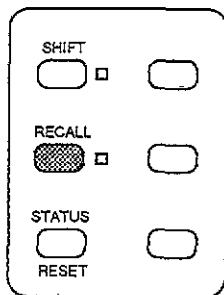

DESCRIPTION

Recall allows you to display individual samples within the measurement. This mode is entered by using the RECALL button. Once in the recall mode, individual samples may be accessed on a sequential or random basis.

OPERATION

To enter recall, simply press the RECALL button. While in this mode, the RECALL indicator button will be on. To access individual samples, either use the uprange or downrange keys to access individual samples, or key in a specific sample number and press the ENTER key.

TRIGGER

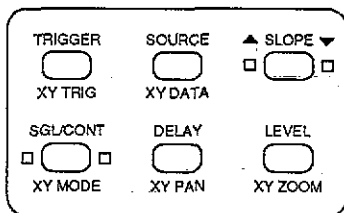

DESCRIPTION

The Model 194A may be triggered in a variety of different ways: with the TRIGGER button, with an input pulse applied to the TRIGGER IN jack, from the other channel, or from the input signal. When triggering from the input signal, the slope and trigger level can be programmed.

OPERATION

SOURCE: To select the trigger source, press SOURCE repeatedly until the desired mode is displayed: front panel (TRIGGER), input signal, external, or other channel. Press CHANNEL to save the selected source.

SGL/CONT: A measurement sequence can be performed on a continuous or single basis. In a continuous mode, the instrument repeatedly arms the A/D for the next trigger measurement without requiring additional triggers. In the single mode, a separate arm stimulus is required for each measurement. SGL/CONT toggles the instrument between these two modes, as indicated by the respective indicator.

TRIGGER: When selected with the SOURCE key, pressing this key will initiate a continuous or single measurement, depending on the selected mode.

SLOPE: Rising or falling edge triggering may be selected with the SLOPE key only when input signal triggering is selected. The annunciator next to the key indicates the selected mode.

LEVEL: When triggering from the input signal, the actual voltage level at which the unit is triggered may be selected with the LEVEL key. Once this mode is entered, the voltage is keyed in with the Data Entry keys.

DELAY: Delay selects the number of samples between the trigger and the first sample. A positive or negative delay may be selected. Delay may be entered in number of samples or actual time by using the FREQ/TIME key.

CHANNEL SELECTION

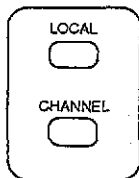

DESCRIPTION

For dual-channel units, the CHANNEL button allows you to select one of three display modes: channel 1, channel 2, or dual-channel display. For the two single-channel modes, the displayed channel also determines which channel will be affected by pressing other keys. In the dual channel mode, most other buttons are inoperative.

INPUT COUPLING

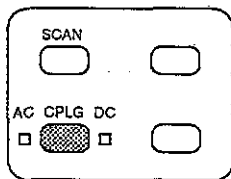

DESCRIPTION

The Model 194A has three available forms of input coupling: ac, dc, and ground. The selected mode of coupling is selected with the CPLG key and indicated by the respective indicators. When ground coupling is selected, both ac and dc will be off.

OPERATION

The input circuit is configured as follows for the three modes:

DC: A straight-through dc signal path is established.

AC: Instrument response is down 3dB at 2Hz.

Ground: The high and low terminals of the input amplifier are shorted together.

ZERO

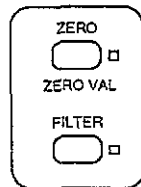

DESCRIPTION

Zero allows a baseline measurement to be subtracted from subsequent measurements. The baseline can be obtained either from an applied signal, or keyed in with the data entry keys. Once a baseline is established, it will be subtracted from measurements until disabled. Any such zero will be subtracted from the from the number to be displayed.

OPERATION

Zeroing an Applied Signal. Connect the signal to act as a zero baseline with zero disabled and press the ZERO key. Apply the measured signal and take readings as usual. The displayed value will be the difference between the applied signal and the stored baseline value.

Keying in the Zero Value. To key in the baseline from the front panel, press SHIFT ZERO VAL, key in the desired value then press ENTER. The baseline will remain in effect as long as the ZERO indicator is on.

FILTER

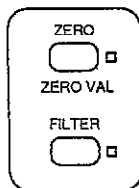

DESCRIPTION

The Model 194A has two available low-pass analog filters with -3dB points of 50kHz and 500kHz . These filters are selected with the FILTER button. When either the 50kHz or 500kHz filters are enabled, the FILTER indicator will be on.

OPERATION

To select one of the filters, simply press the FILTER button until the correct display message is shown (50kHz , 500kHz , or off). When the desired filter is shown, press the CHANNEL key to return to the previous mode.

FRONT PANEL PROGRAMS

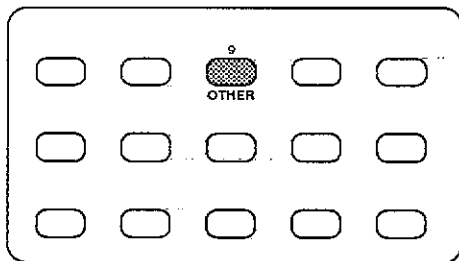

DESCRIPTION

The OTHER key allows selection of a number of front panel program modes as follows: IEEE-488 address; self test; digital calibration; NVRAM storage; X output full scale value; Y output full scale value; and Z output blanking level. These programs are numbered 0-6, and are entered by pressing the OTHER key. Once this mode has been entered, you can either key in the appropriate digit, or use the uprange and downrange keys to scroll through available programs.

OPERATION

IEEE-488 Address (SHIFT, OTHER, 0): Once entered, you can program a valid primary address (0-30) by using the Data Entry or cursor keys and then pressing enter.

Self Test (SHIFT, OTHER,1): Performs a self test on internal instrument circuitry and will return appropriate error messages.

Digital Calibration (SHIFT, OTHER, 2): Digital calibration, which requires specialized test equipment, is performed by this program.

NVRAM Storage (SHIFT,OTHER,3): Stores calibration constants in NVRAM once the unit is calibrated.

X Output Full Scale (SHIFT,OTHER,4): Programs the maximum voltage at the X analog output jack.

Y Output Full Scale (SHIFT, OTHER, 5): Sets the maximum voltage of the Y analog output...

Z Output Blanking Level (SHIFT, OTHER,6): Determines the blanking level at the Z analog output.

SETUP

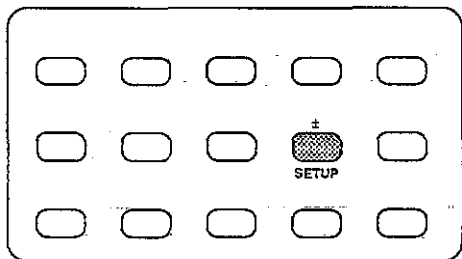

DESCRIPTION

Setup allows you to store up to two different instrument configurations in NVRAM. These setups can then be later

recalled, thus simplifying instrument configuration for a variety of different test procedures.

OPERATION

Saving Setups: Select the channel (or scanner) to be configured and program the desired modes. Press the SETUP button twice followed by the desired setup number (1-2). Press ENTER to store the selected configuration. Setup 0 contains the factory defaults and cannot be reprogrammed.

Recalling Setups: Press SETUP followed by the desired setup number. Press the ENTER key to recall the desired setup.

STATUS

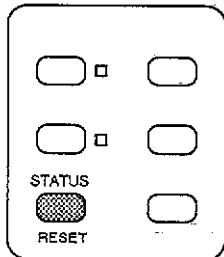

DESCRIPTION

The current instrument status for both channels, can be determined by recalling instrument status with STATUS key.

The returned status values will depend on the present selected operating modes.

OPERATION

To access instrument status, simply press the **STATUS** key once, the unit will display the following status parameters in the following order, moving through the list at about one item per second:

Zero value

Filter status (50kHz or 500kHz)

Trigger source

Trigger mode

Trigger delay

Trigger level

Sample rate

Measurement size

Maximum sample rate for each resolution

RESET

DESCRIPTION

The **RESET** key allows you to quickly return the instrument to the power-on default configuration (setup 1). Both A/D channels will be affected by this key.

OPERATION

To simulate a power on reset, simply press **SHIFT RESET**.

XY MODE

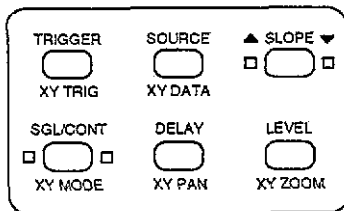

DESCRIPTION

The XY mode allows you to plot your data on a display device such as a CRT, oscilloscope, or plotter. Connections to these plotting devices is made through the X, Y, and Z analog output jacks on the rear panel. Various scaling factors can be applied to the data before being plotted.

OPERATION

XY MODE: Enters the XY mode and allows the selection of the type of plotting device: CRT, oscilloscope, or plotter.

XY DATA: Allows you to select the source of data to be displayed, individual samples from the measurement buffer, or readings from the display buffer for either channel 1 or channel 2.

XY TRIG: Used to start and stop the analog output sequence.

XY ZOOM: Provides a method of scaling data located in the buffer to the display window.

XY PAN: Controls which data point is the first displayed in the window.

INPUT AND OUTPUT CONNECTIONS

A/D MODULE INPUT/OUTPUT CONNECTIONS

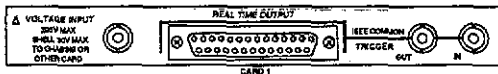

DESCRIPTION

Each A/D module has several input or output connectors on the rear panel for voltage signal input, real time output, and trigger input and output. Each of these connectors is briefly described below.

OPERATION

VOLTAGE INPUT: All voltage input signals are applied to this BNC jack for processing and A/D conversion. Note that the maximum input voltage is 250V peak, 2×10^6 V Hz. The maximum common mode voltage is 30V.

REAL TIME OUTPUT: A/D data at the sampling rate may be read via this output. Data can be transmitted in 8-bit or 16-bit format. This connector is also used to select between internal and external sample rate clocks.

TRIGGER IN: A negative-going pulse at TTL levels (10 μ sec minimum) can be applied to this jack to one trigger a measurement. External triggering must be selected with the SOURCE key before this connector is active.

TRIGGER OUT: A negative going $10\mu\text{sec}$ pulse at TTL levels will appear at this jack when a valid measurement trigger occurs. The pulse will occur regardless of the selected trigger source.

ANALOG OUTPUT CONNECTIONS

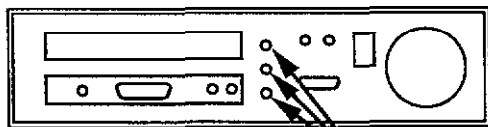

Analog Output Jacks

DESCRIPTION

The analog output includes three jacks located on the rear panel, labeled X, Y, and Z. Signals appearing at these jacks are controlled by the XY mode. Each jack is a standard BNC connector.

X OUTPUT: This signal, which provides time information, should be used as an X-axis signal for a plotter or CRT.

Y OUTPUT: The Y output provides amplitude about the various samples, and should be used as a Y-axis signal for the CRT and plotter, and vertical input information for an oscilloscope.

Z OUTPUT: The Z output provides a blanking pulse for a CRT, an external trigger pulse for an oscilloscope, or a pen up signal for a plotter.

EXTERNAL CLOCK



DESCRIPTION

The external clock jacks provide methods of synchronizing two or more Model 194s together to a common time base, as described below.

OPERATION

CLK IN: An externally generated 10MHz clock at TTL levels can be applied to this input to synchronize sample taking to an external time base. Detection and switching is automatic.

CLK OUT: Normally, the internal 10MHz clock (TTL levels) of the Model 194A will appear at this output. If the unit is operating with an external time base, the external clock rate will appear at CLK OUT instead.

Synchronizing units: To synchronize units, connect the CLK OUT of the master unit to the CLK in of the slave unit. Other units may be daisy chained in a similar manner.

IEEE-488 PROGRAMMING

DEVICE-DEPENDENT COMMANDS

FUNCTION	
F0	Waveform (sample at trigger point)
F1	Average
F2	TRMS
F3	+ Peak
F4	- Peak
F5	Peak-to-peak
F6	Standard deviation
F7	Integral
F20	CH1-CH2
F21	CH1/CH2

RANGE	
R0	Auto
R1	320mV
R2	3.2V
R3	32V
R4	200V
R12	Cancel auto (stay on present range)

RATE	
S0,m	m = sampling rate in sec ($1E-6 \leq m \leq 1\text{sec}$)
S1,m	m = sampling frequency in Hz ($1 \leq m \leq 1E6\text{Hz}$)

NUMBER SAMPLES

N0,m	m = number of samples ($1 \leq m \leq 65,536$, 8-bit; $1 \leq m \leq 32,767$, 16-bit)
N1,m	m = measurement duration in sec ($0 \leq m \leq 65,534E3$, 8-bit; $0 \leq m \leq 32,766$, 16-bit)

TRIGGER

T0	Continuous, talk
T1	Single, talk
T2	Continuous, GET
T3	Single, GET
T4	Continuous, X
T5	Single, X
T6	Continuous, external
T7	Single, external
T20,m	Continuous, + slope, level m ($-200 \leq m \leq +200V$)
T21,m	Single, + slope, level m ($-200 \leq m \leq +200V$)
T22,m	Continuous, - slope, level m ($-200 \leq m \leq +200V$)
T23,m	Single, - slope, level m ($-200 \leq m \leq +200V$)
T24	Continuous, other channel
T25	Single, other channel
T26	Continuous, immediate
T27	Single, immediate
T30	Start plotter
T31	Stop plotter

DELAY	
W0,±m	Delay in number of samples (-65,536 ≤ m ≤ 1E7)
W1,±m	Delay in sec (-65,536 ≤ m ≤ 1E7)

DATA FORMAT	
G0	ASCII, 1 rdg, prefix on, suffix off
G1	ASCII, 1 rdg, prefix off, suffix off
G2	ASCII, 1 rdg, prefix on, suffix on
G3	ASCII, n rdgs, prefix on, suffix off
G4	ASCII, n rdgs, prefix off, suffix off
G5	ASCII, n rdgs, prefix on, suffix on
G6	Binary, n rdgs, prefix off, suffix off
G7	Binary, n rdgs (byte count), prefix off, suffix off

ANALOG OUTPUT

O0	Abort plotter
O1	Test Analog Output (all outputs=full scale)
O2,0	XY mode off
O2,1	CRT mode
O2,2	Scope mode
O2,3	Future expansion
O2,4	Slow plot (XY analog plotter)
O2,5	Strip chart
O3,0	Measurement buffer
O3,1	64k RAM buffer
O3,2	Display readings
O3,3	IEEE-488 reading buffer
O4,m	m=X output full scale voltage ($1 \leq m \leq 10$)
O5,m	m=Y output full scale voltage ($1 \leq m \leq 10$)
O6,m	m=Z output blanking level (1=high, 0=low)
O7,m	m=XY zoom value ($0.1 \leq m \leq 1000$)
O8,m	m=XY pan value ($-65,536 \leq m \leq 65,536$)
O9	Start plotter

BUFFER POINTER

B0	Clear waveform output, decrement reading buffer pointer.
B1,m	Set measurement buffer start pointer to m.
B2,m	Set measurement buffer end pointer to m.
B3,m	Set reading buffer start pointer to m.

READING BUFFER	
Q0	Reading buffer off.
Q1	Linear reading buffer on.
Q2	Circular reading buffer on.

FILTER	
P0	Filter off
P1	500kHz filter
P2	50kHz filter

ZERO	
Z0	Disable zero
Z1	Enable zero
Z2	Use next measurement as baseline
Z3,m	Use value m as baseline value ($-200 \leq m \leq +200V$)
Z4	$Z2 + Z1$
Z5,m	$Z3 + Z1$ ($-200 \leq m \leq +200V$)

INPUT COUPLING	
I0	Dc coupling
I1	Ac coupling
I2	Ground coupling

STATUS

U0	Current channel status
U1	Error status
U2	Data status
U3	Zero (Z) parameter
U4	Delay (W) parameter
U5	Number samples (N) parameter
U6	Sample rate (S) parameter
U8	Trigger level
U9	Measurement buffer start pointer
U10	Measurement buffer end pointer
U11	Reading buffer start pointer
U12	Get Translator list

SRQ

M0	SRQ disabled
M1	Overflow
M2	Data condition
M4	Button pressed
M8	Reading done
M16	Ready
M32	Error

CHANNEL

C1	Channel 1 A/D module
C2	Channel 2 A/D module
C12	Composite channel 1 and 2 display.

EOI, HOLD OFF

K0	EOI and hold off on X enabled
K1	EOI disabled, hold off on X enabled
K2	EOI enabled, hold off on X disabled
K3	Both EOI and hold off on X disabled

TERMINATOR

Ym	Program m as single terminator
Yn,m	Program mn as dual terminator
Y (DEL)	No terminator

SAVE*

L1	Save setup 1
L2	Save setup 2
L4,m	Calibrate using value m ($-200 \leq m \leq +200V$)
L5	Store cal in NVRAM

RECALL

A0	Recall factory setup
A1	Recall setup 1
A2	Recall setup 2

HIT BUTTON

Hn	Act as if button n (1-38) has been pressed
----	--

DISPLAY

DaaaaX	Display ASCII characters aaaa (14 maximum)
DX	Return to normal display mode

SELF TEST

J1	U1 self test byte = 1: fail
----	-----------------------------

EXECUTE

X	Execute other device-dependent commands
---	---

NOTE: The following characters may be used as delimiter in place of comma:
! @ # \$ % ^ & () = \ / < > ? : ; <space>

*m parameter is in microvolts.

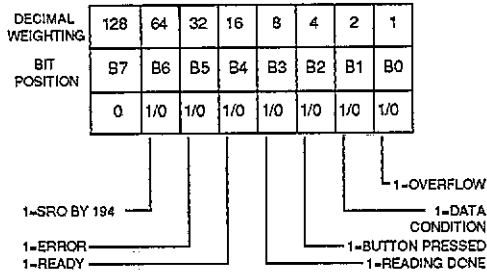

Figure 1. SRQ Mask and Status Byte Format

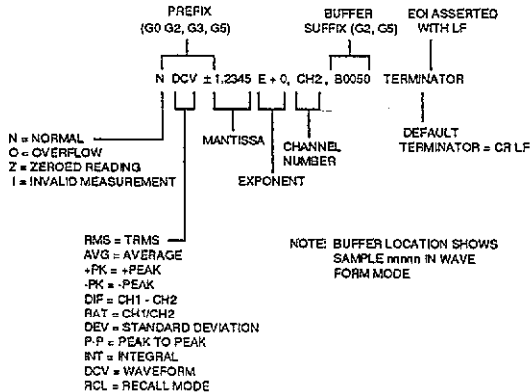
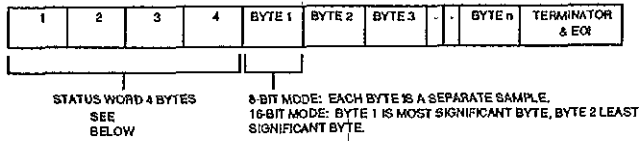

Figure 2. ASCII Data Format (G0 to G5)

Figure 3. Binary Data Format

A. G6



B. G7

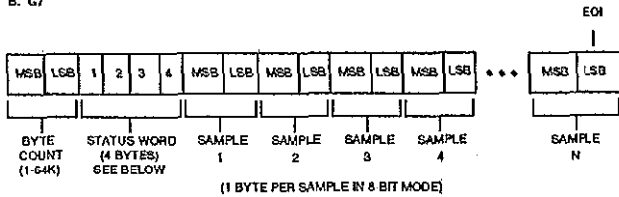
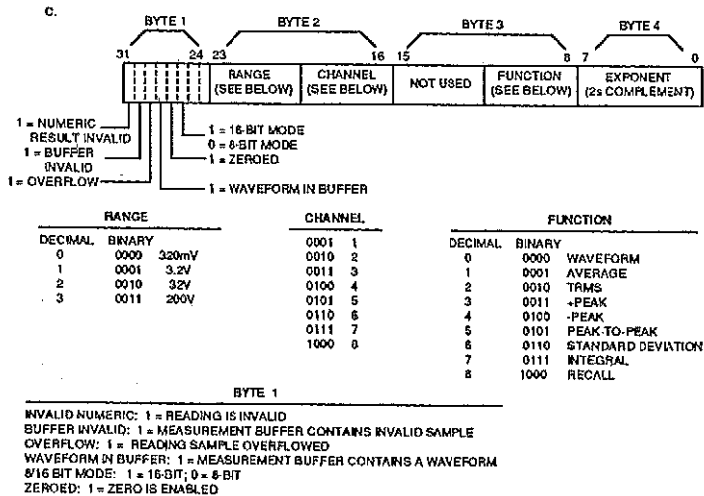

Figure 3. Binary Data Format (Cont.)



194FnnRnnTnnPnZnKnHnnInAnLnQnGnJnnCnnMnnYnnnnnTERMINATOR

MODEL NUMBER (194)

FUNCTION (Fnn)

00=WAVEFORM
01=AVERAGE*
02=TRMS
03=+PEAK
04=-PEAK
05=PEAK TO PEAK
06=STANDARD DEVIATION
07=INTEGRAL
20=CH1-CH2
21=CH1/CH2

RANGE (Rnn)

0=AUTO*
1=320mV
2=3.2V
3=32V
4=200V

TRIGGER (Tnn)

00=CONTINUOUS, TALK
01=SINGLE, TALK
02=CONTINUOUS, GET
03=SINGLE, GET
04=CONTINUOUS, X
05=SINGLE, X
06=CONTINUOUS, EXTERNAL
07=SINGLE, EXTERNAL
20=CONTINUOUS, +SLOPE
21=SINGLE, +SLOPE

Figure 4. U0 Status Word Format

22=CONTINUOUS, -SLOPE
23=SINGLE, -SLOPE
24=CONTINUOUS, OTHER CHANNEL
25=SINGLE, OTHER CHANNEL
26=CONTINUOUS, IMMEDIATE*
27=SINGLE, IMMEDIATE
30=START PLOTTING
31=STOP PLOTTING

FILTER (Pn)

0=OFF*
1=500kHz
2=50kHz

ZERO (Zn)

0=DISABLED*
1=ENABLED
2=SAVE MEAS
3=USE VAL.
4=Z1 + Z2
5=Z1 + -Z3

EOI, BUS HOLD OFF (Kn)

0=EOI, HOLD OFF*
1=NO EOI, HOLD OFF
2=EOI, NO HOLD OFF
3=NO EOI, NO HOLD OFF

BUTTON PRESSED (Hnn)

00=NONE
01=ZERO
02=FILTER
03=TRIGGER
04=SGL/CONT
05=SOURCE
06=DELAY

Figure 4. U0 Status Word Format (Cont.)

07=SLOPE
08=LEVEL
09=SCAN
10=CPLG
11=SAMPLES
12=RATE
13=LOCAL
14=CHANNEL
15=AUTO

16=▲▶
17=◀▼

18=SHIFT
19=RECALL
20=STATUS
21=ENTER
22=CANCEL
23=FREQ/TIME
24=7
25=4
26=1
27=8
28=5
29=2
30=9
31=6
32=3
33=0
34=±
35=•
36=MHz
37=kHz
38=Hz

Figure 4. U0 Status Word Format (Cont.)

INPUT COUPLING (In)

0=DC COUPLING*
1=AC COUPLING
2=GROUND COUPLING

RECALL SETUP (An)

0=FACTORY SETUP*
1=SETUP 1*
2=SETUP 2

SAVE (Ln)

1=SAVE SETUP 1*
2=SAVE SETUP 2
4=CALIBRATE USING VALUE
5=STORE CAL IN NVRAM

READING BUFFER (Qn)

0=DISABLED*
1=LINEAR BUFFER
2=CIRCULAR BUFFER, OVERWRITE

DATA FORMAT (Gn)

0=ASCII, PREFIX ON, SUFFIX OFF, 1RDG
1=ASCII, PREFIX OFF, SUFFIX OFF, 1RDG
2=ASCII, PREFIX ON, SUFFIX ON, 1RDG*
3=ASCII, PREFIX ON, SUFFIX OFF, n RDGS
4=ASCII, PREFIX OFF, SUFFIX OFF, n RDGS
5=ASCII, PREFIX ON, SUFFIX ON, n RDGS
6=BINARY, PREFIX OFF, SUFFIX OFF
7=BINARY, PREFIX OFF, SUFFIX OFF, BYTE COUNT

SELF TEST (Jnn)

CODE/MEANING
00=NO ERROR
01=SELFTEST COMPLETE, NO ERROR
(GOES TO 00 UO READ)

Figure 4. U0 Status Word Format (Cont.)

02=NOT USED
03=NOT USED
04=NOT USED
05=NOT USED
06=NOT USED
07=NOT USED
08=RAM ERROR ON MOTHERBOARD
09=ROM ERROR ON MOTHERBOARD
1X=A/D ERROR ON CH1
(SEE TABLE BELOW FOR X MEANING)
2X=A/D ERROR ON CH2
(SEE TABLE BELOW FOR X MEANING)

A/D ERROR CODES

0=NOISY A/D
1=NOT USED
2=INOPERATIVE CAL ADJUSTMENT
3=NOT USED
4=NOT USED
5=TIMEBASE ERROR
6=NOT USED
7=RAM ERROR

CHANNEL (Cnn)

01=CHANNEL 1*
02=CHANNEL 2
12=COMPOSITE CHANNEL

SRQ (Mnnn)

000=DISABLED*
001=OVERFLOW
002=DATA
004=HIT BUTTON
008=READING DONE
016=READY
032=ERROR

Figure 4. U0 Status Word Format (Cont.)

TERMINATOR (Ynnnnnn)
nnnnnn=Y(ASCII)
000000=NO TERMINATOR
013010=CR LF*

TERMINATOR
DEFAULT CR LF

*FACTORY DEFAULT

Figure 4. U0 Status Word Format (Cont.)

**BUTTON NUMBERS USED BY HIT COMMAND
AND RETURNED IN U0 STATUS**

Command	Button	Command	Button
0	None	21	ENTER
1	ZERO	22	CANCEL
2	FILTER	23	FREQ/TIME
3	TRIGGER	24	7
4	SGL/CONT	25	4
5	SOURCE	26	1
6	DELAY	27	8
7	SLOPE---	28	5
8	LEVEL	29	2
9	SCAN	30	9
10	CPLG	31	6
11	SAMPLES	32	3
12	RATE	33	0
13	LOCAL	34	+/-
14	CHANNEL	35	.
15	AUTO	36	MHz
16	Uprange	37	kHz
17	Downrange	38	Hz
18	SHIFT		
19	RECALL		
20	STATUS		

Figure 5. U1 Status Word Format

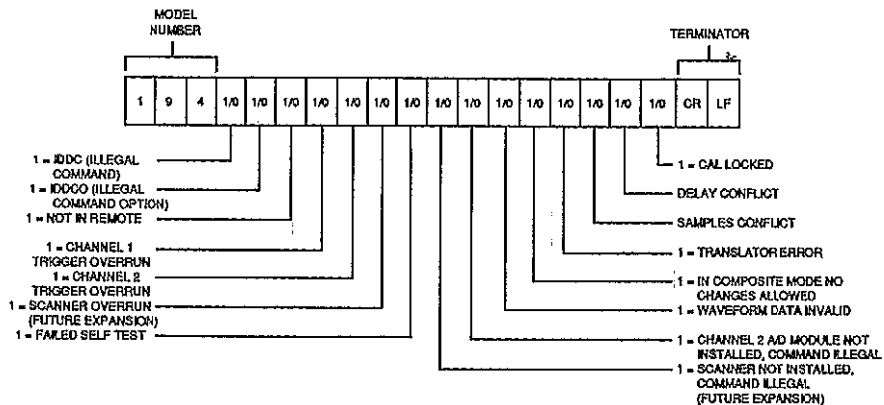

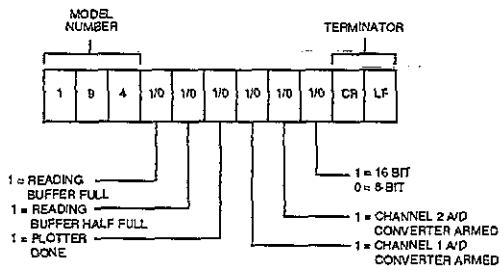

Figure 6. U2 Status Word Format

Z	±	n	n	n	n	n	n	n	n	n	TERMINATOR
---	---	---	---	---	---	---	---	---	---	---	------------

A. U3 (ZERO VALUE) STATUS

W	±	n	n	n	n	n	TERMINATOR
---	---	---	---	---	---	---	------------

B. U4 (DELAY) STATUS

N	+	n	n	n	n	TERMINATOR
---	---	---	---	---	---	------------

C. U5 (NUMBER OF SAMPLES) STATUS

S	+	n	n	n	n	n	n	n	TERMINATOR
---	---	---	---	---	---	---	---	---	------------

D. U6 (SAMPLING RATE) STATUS

I	+	0	0	0	0	TERMINATOR
---	---	---	---	---	---	------------

E. U7 STATUS (NOT USED)

L	±	n	n	n	n	TERMINATOR
---	---	---	---	---	---	------------

F. U6 (TRIGGER LEVEL) STATUS

B	+	n	n	n	n	TERMINATOR
---	---	---	---	---	---	------------

G. U9 (MEASUREMENT BUFFER START POINTER) STATUS

E	+	n	n	n	n	TERMINATOR
---	---	---	---	---	---	------------

H. U10 (MEASUREMENT BUFFER END POINTER) STATUS

B	+	n	n	n	n	TERMINATOR
---	---	---	---	---	---	------------

I. U11 (READING BUFFER POINTER) STATUS

Figure 7. U3-U11 Status Word Formats

TRANSLATOR MODE

DESCRIPTION

The Translator mode allows you to substitute English-like words in place of device-dependent commands or commands strings. For example the word SAMPLES could take the place of the command N1000X, which programs the instrument to take 1000 samples. A single word can also replace a group of commands at one time. For example, the word SETUP1 could be used to replace the following command string: F1S+100N250W+25Z1P2X.

RESERVED WORDS AND SYMBOL

Translator reserved words and symbol are listed below, along with a brief description of each word.

Reserved Word	Description
ALIAS	Define Translator words, enable Translator.
NEW	Enable Translator, combine words.
OLD	Disable Translator.
LIST	Get list of Translator words from instrument.
FORGET	Purge Translator words.
;	Terminate Translator command string.

EXAMPLES

"ALIAS SETUP1 ROF1X ;" — Defines the word SETUP1 in place of ROF1X.

"ALIAS TEST4 N1000S+10IOX ;" — Defines TEST4 in place of N1000S+10IOX.

CONTROLLER PROGRAMS

The following programs have been supplied as a simple aid to demonstrate basic programming techniques and are not intended to suit specific needs. Each program allows you send a device-dependent command string to the instrument and obtain and display an instrument reading string. The returned data is an ASCII string variable of the form:

NAVG+1.2345 CR LF

Here, CR LF represents the default carriage return, line feed terminator and will not normally be displayed.

A note included with each program indicates modifications necessary to provide a numeric variable of the form:

+1.2345

Programs for the following controllers are included:

IBM PC or XT (with CEC IEEE-488 interface).

Hewlett-Packard 300 series computer running BASIC.

IBM XT or PC (with CEC Interface)

Initialization:

```
DEF SEG = &HC400          'memory segment for
                           PC <> 488
INITIALIZE% = 0: SEND% = 36 ' offsets for PC <> 488
                           routines
ENTER% = 39: LEVEL% = 0   ' offsets for PC <> 488
                           routines
MY.ADDRESS% = 21          ' make PC a controller at
                           address 21
CALL ABSOLUTE             ' initialize system
(MY.ADDRESS%, LEVEL%,
INITIALIZE%)
ADDRESS% = 9              ' the instrument is at address
                           09
```

SendCommand:

```
INPUT "COMMAND"; S$      ' get command
CALL ABSOLUTE            ' send command
(ADDRESS%, S$, STATUS%,
SEND%)
IF STATUS% <> 0 THEN      ' test for errors in sending
STOP
```

TakeReading:

```
R$ = SPACE$(255)         ' make space for reading
CALL ABSOLUTE (R$,      ' command to receive.
LENGTH%, ADDRESS%,
STATUS%, ENTER%)
IF STATUS% <> 0 THEN      ' test for errors in enter
STOP
PRINT LEFT$(R$, LENGTH%)
GOTO SendCommand
END
```

HEWLETT-PACKARD SERIES 300

The following program sends a command string to the Model 194A from a Hewlett-Packard Model 310 computer and displays the instrument reading string on the computer CRT. The computer must be equipped with the HP82937 GPIB Interface and HP BASIC 4.0

DIRECTIONS

1. Using the front panel program feature, set the primary address of the Model 194A to 9.
2. With the power off, connect the Model 194A to the HP82937A GPIB interface installed in the 9816 computer.
3. Type EDIT and press the EXEC key.
4. Enter the lines in the program below, using the ENTER key after each line.
5. Press the 9816 RUN key and type in the desired command string at the command prompt. For example, to place the instrument in the autorange and average modes, type in ROF1X and press the ENTER key.
6. The instrument reading string will then appear on the CRT. A typical display is: DAVG+1.2345.

PROGRAM	COMMENTS
10 REMOTE 709	Place 194A in remote.
20 INPUT "COMMAND STRING" ; A\$	Prompt for and input command.
30 OUTPUT 709; A\$	Address 194A to listen, send string.
40 ENTER 709; B\$	Address 194A to talk, input reading.
50 PRINT B\$	Display reading string.
60 GOTO 20	Repeat.
70 END	

NOTE: For conversion to a numeric variable, change the program as follows:

```
40 ENTER 709: B
50 PRINT B
```

ASCII Character Codes and IEEE-488 Multiline Interface Command Messages

Decimal	Hexadecimal	ASCII	IEEE-488 Message*
0	00	NUL	
1	01	SOH	GTL
2	02	STX	
3	03	ETX	
4	04	EOT	SDC
5	05	ENQ	PPC
6	06	ACK	
7	07	BEL	
8	08	BS	GET
9	09	HT	TCT
10	0A	LF	
11	0B	VT	
12	0C	FF	
13	0D	CR	
14	0E	SO	
15	0F	SI	
16	10	DLE	
17	11	DC1	LLO
18	12	DC2	
19	13	DC3	
20	14	DC4	DCL
21	15	NAK	PPU
22	16	SYN	
23	17	ETB	
24	18	CAN	SPE
25	19	EM	SPD
26	1A	SUB	
27	1B	ESC	
28	1C	FS	
29	1D	GS	
30	1E	RS	
31	1F	US	

* Message sent or received with ATN true.

Decimal	Hexadecimal	ASCII	IEEE-488 Message*
32	20	SP	MLA 0
33	21	!	MLA 1
34	22	"	MLA 2
35	23	#	MLA 3
36	24	\$	MLA 4
37	25	%	MLA 5
38	26	&	MLA 6
39	27	,	MLA 7
40	28	(MLA 8
41	29)	MLA 9
42	2A	*	MLA 10
43	2B	+	MLA 11
44	2C	,	MLA 12
45	2D	-	MLA 13
46	2E	.	MLA 14
47	2F	/	MLA 15
48	30	0	MLA 16
49	31	1	MLA 17
50	32	2	MLA 18
51	33	3	MLA 19
52	34	4	MLA 20
53	35	5	MLA 21
54	36	6	MLA 22
55	37	7	MLA 23
56	38	8	MLA 24
57	39	9	MLA 25
58	3A	:	MLA 26
59	3B	;	MLA 27
60	3C	<	MLA 28
61	3D	=	MLA 29
62	3E	>	MLA 30
63	3F	?	UNL

* Message sent or received with ATN true. Numbers shown represent primary address resulting in MLA (My Listen Address).

Decimal	Hexadecimal	ASCII	IEEE-488 Message*
64	40	@	MTA 0
65	41	A	MTA 1
66	42	B	MTA 2
67	43	C	MTA 3
68	44	D	MTA 4
69	45	E	MTA 5
70	46	F	MTA 6
71	47	G	MTA 7
72	48	H	MTA 8
73	49	I	MTA 9
74	4A	J	MTA 10
75	4B	K	MTA 11
76	4C	L	MTA 12
77	4D	M	MTA 13
78	4E	N	MTA 14
79	4F	O	MTA 15
80	50	P	MTA 16
81	51	Q	MTA 17
82	52	R	MTA 18
83	53	S	MTA 19
84	54	T	MTA 20
85	55	U	MTA 21
86	56	V	MTA 22
87	57	W	MTA 23
88	58	X	MTA 24
89	59	Y	MTA 25
90	5A	Z	MTA 26
91	5B	[MTA 27
92	5C	\	MTA 28
93	5D]	MTA 29
94	5E	^	MTA 30
95	5F	-	UNT

* Message sent or received with ATN true. Numbers shown are primary address resulting in MTA (My Talk Address).

Decimal	Hexadecimal	ASCII	IEEE-488 Message*
96	60		MSA 0,PPE
97	61	a	MSA 1,PPE
98	62	b	MSA 2,PPE
99	63	c	MSA 3,PPE
100	64	d	MSA 4,PPE
101	65	e	MSA 5,PPE
102	66	f	MSA 6,PPE
103	67	g	MSA 7,PPE
104	68	h	MSA 8,PPE
105	69	i	MSA 9,PPE
106	6A	j	MSA 10,PPE
107	6B	k	MSA 11,PPE
108	6C	l	MSA 12,PPE
109	6D	m	MSA 13,PPE
110	6E	n	MSA 14,PPE
111	6F	o	MSA 15,PPE
112	70	p	MSA 16,PPD
113	71	q	MSA 17,PPD
114	72	r	MSA 18,PPD
115	73	s	MSA 19,PPD
116	74	t	MSA 20,PPD
117	75	u	MSA 21,PPD
118	76	v	MSA 22,PPD
119	77	w	MSA 23,PPD
120	78	x	MSA 24,PPD
121	79	y	MSA 25,PPD
122	7A	z	MSA 26,PPD
123	7B	{	MSA 27,PPD
124	7C		MSA 28,PPD
125	7D	}	MSA 29,PPD
126	7E	~	MSA 30,PPD
127	7F	DEL	

* Message send or received with ATN true. Numbers represent secondary address values resulting in MSA (My Secondary Address).